

Path Computation Architectures Overview of Multi-domain Optical Networks Based on ITU-T ASON and IETF PCE

www.huawei.com

**Daniel King (Aria), Young Lee (Huawei),
Huiying Xu (Huawei), Adrian Farrel (Old Dog)**

IEEE BoD Workshop 2008, Salvador, Brazil



Aria Networks



HUAWEI

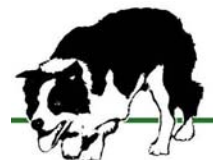

Old Dog Consulting

Agenda

- ITU-T ASON Architecture
- Issues for Routing in Multi-Domain Networks
- The ASON Hierarchical Routing Concept
- TE Aggregation Issues
- PCE Architecture Overview
- Per-Domain Path Computation
- Backward Recursive Path Computation
- Multi-Layer PCE Architecture



ITU-T ASON Control Plane Architecture G.7713.2

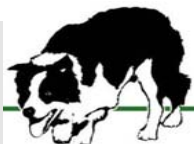
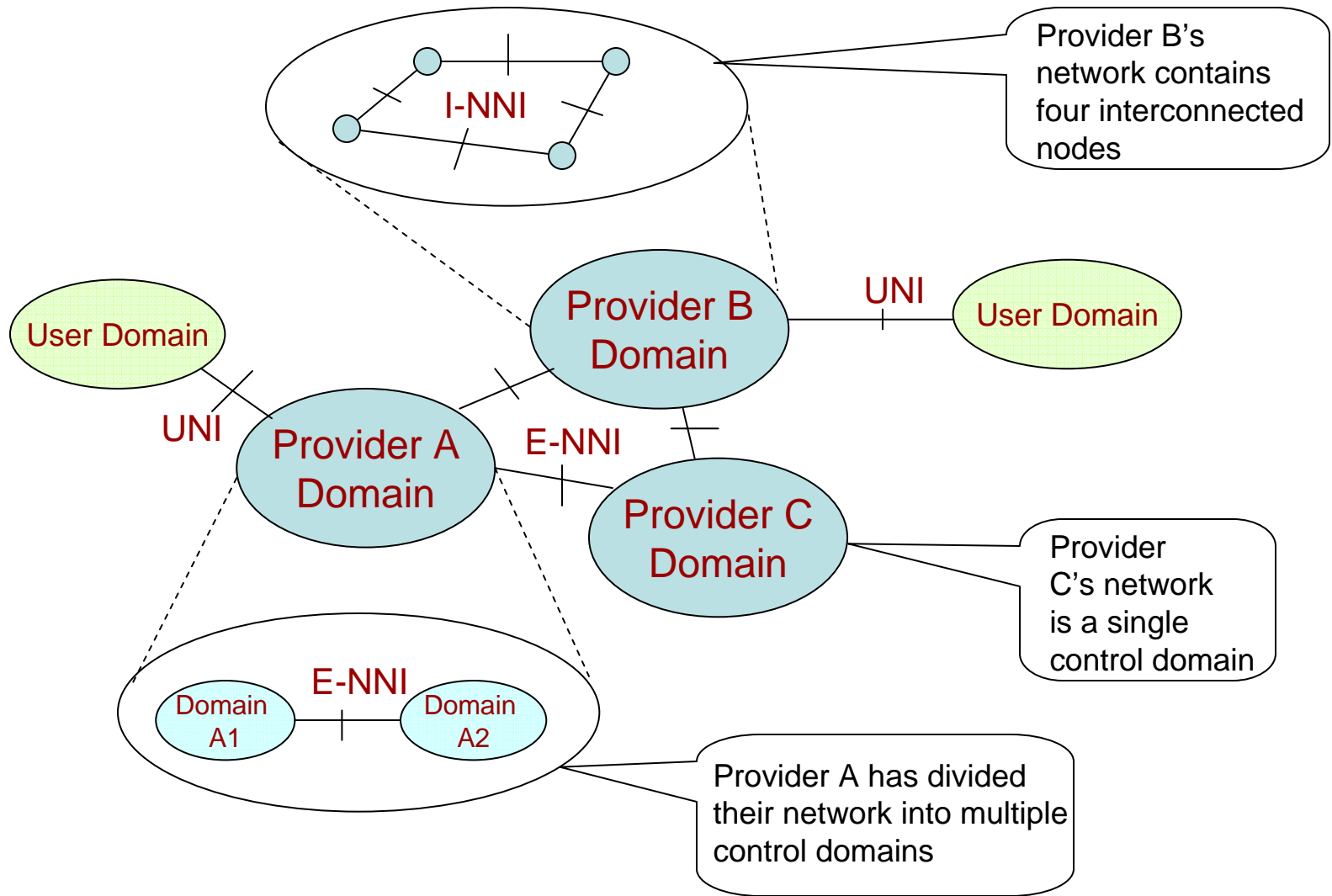

Issues for Routing in Multi-Domain Networks

- The lack of full topology and TE information.
- No single node has the full visibility to determine an optimal or even feasible end-to-end path.
- How to select the exit point and next domain boundary from a domain.
- How can a head-end determine which domains should be used for the end-to-end path?
- Information exchange across multiple domains is limited due to the lack of trust relationship, security issues, or scalability issues even if there is trust relationship between domains.



The ASON Hierarchical Routing Concept

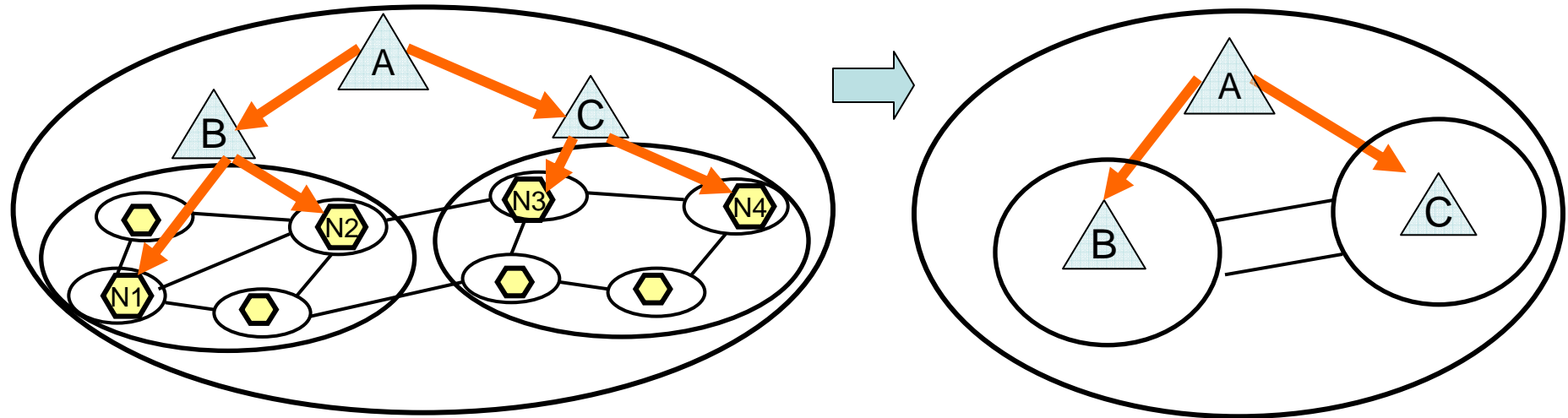

• Routing Controllers

- Nodes responsible for distributing routing information
- Nodes responsible for computing paths

• Routing Area

- A community of RCs
- RCs exchange routing information within the RA and can compute paths within the RA

• Routing Level - a community of RAs

- Parent-Child Relationship – A RC at one level in the hierarchy can communicate with its parents and its children and sees the sub-networks within its domain as virtual nodes
- Hierarchical “containment” relationship of RAs that defines routing levels fully
- The Parent RC has no visibility into the child domains => Need solutions



Alternative Approaches

- **Approach 1: Modified ASON Hierarchical Routing Concept**
 - **Allow RC at the lower level to distribute routing information to the higher level routing controller.**
 - What/how much information?
 - Full information exchange defeats reason for separate levels
- **Approach 2: OIF DDRP (Domain-to-Domain Routing Protocol)**
 - **Experimental protocol based on IETF OSPF**
 - **Redistributes TE information at the E-NNI**
 - **Flooding of information between peer Routing Areas (RA)**
 - What/how much information?
 - Full information exchange defeats reason for separate RAs
- **Scalability is a big issue for both unless some form of TE aggregation is used.**



TE Aggregation

Virtual Node Aggregation Model

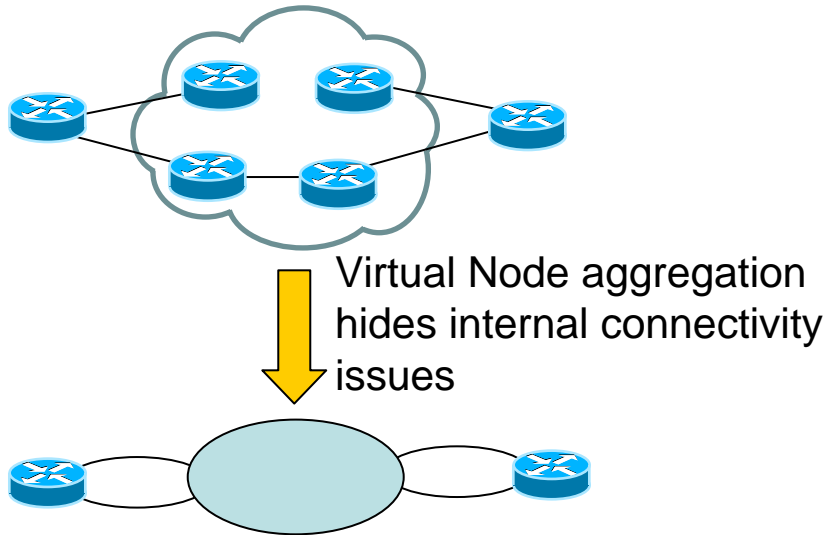

Virtual Link Aggregation Model

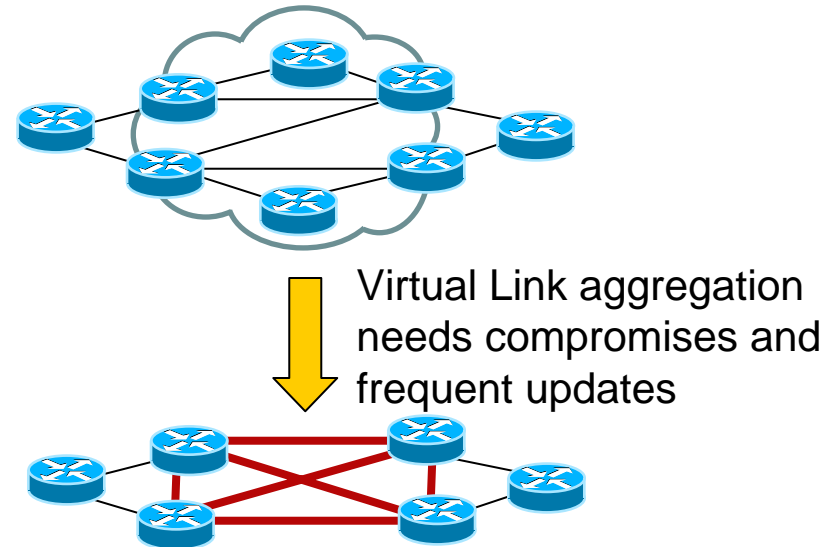

- TE Aggregation helps to scale, but there are several issues:
 - **May hide connectivity issues**
 - **May cause confusing aggregation of information**
 - **May need frequent updates as internal information changes**
 - **Optimality is in doubt**



Constructing Inter-Domain Paths

- Three techniques: Contiguous, Hierarchical, or Stitched
- **Contiguous** LSP: A single, end-to-end connection established by a single signaling exchange.
- **Hierarchical** LSP: The end-to-end LSP is tunneled through a hierarchical LSP that spans a transit domain.
- **Stitched** LSP: An LSP is set up across each domain, and these segments are stitched together at the domain boundaries under the control of an end-to-end signalling request.
- Unanswered issues
 - How to compute end-to-end paths
 - How to select domain border nodes

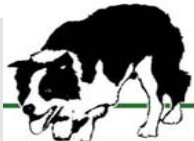
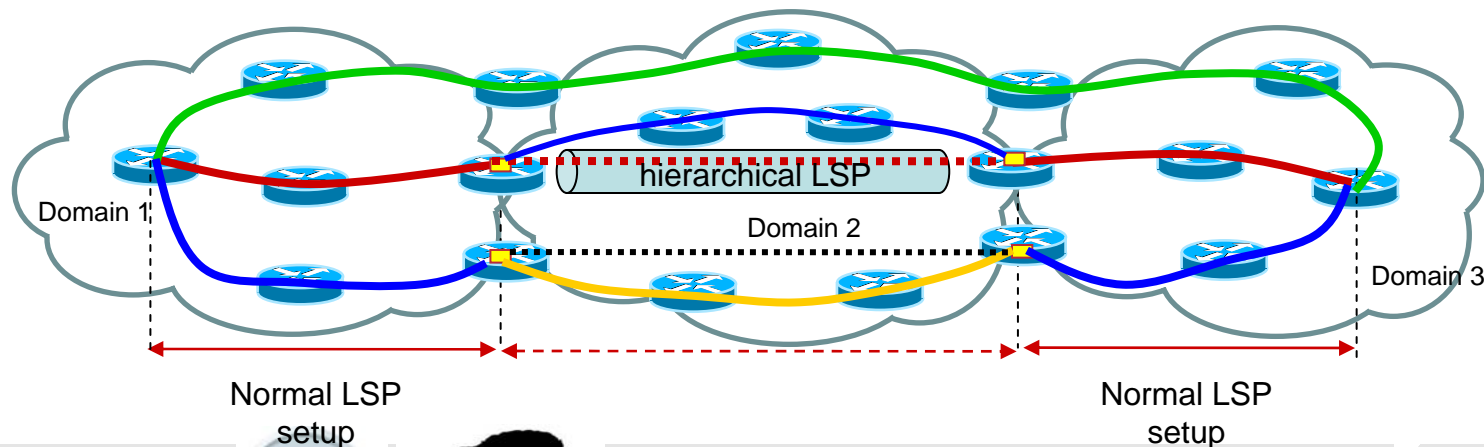

Path Computation Element (PCE)

“An entity (component, application, or network node) that is capable of computing a network path or route based on a network graph and applying computational constraints” - RFC 4655

- PCE is a path computation element (e.g., server) that specializes in complex path computation on behalf of its path computation client (PCC)
- PCEP is the standard IETF communication protocol running between PCE and PCC

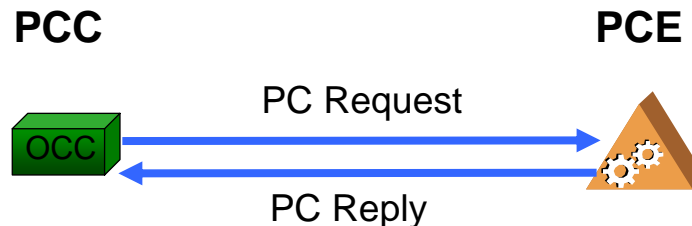

PCC can be
(i) OCC
(ii) NE
(iii) NMS



Path Computation in Optical Networks

- WSON Elements and Subsystem Information should be defined clearly and made available to GMPLS/ASON Control Plane
 - **Wavelength level information availability**
 - **Wavelength Convertible/Non-convertible Ports**
- Path Computation for light-paths has multiple constraints:
 - **Routing constraints: reachability, cost, path diversity, protection level, etc.**
 - **RWA constraints: wavelength continuity, cross-connect capabilities**
 - **Optical Impairment Constraints: power, OSNR, PMD, etc.**
- Computational complexity of multi-constraint path computation
 - **Multi-commodity flow model is typically NP-Complete**
 - **Concurrent path computation requires higher computational resources and a global visibility**



Challenges in WSON Path Computation!



GMPLS based Distributed Control Plane for Optical Networks

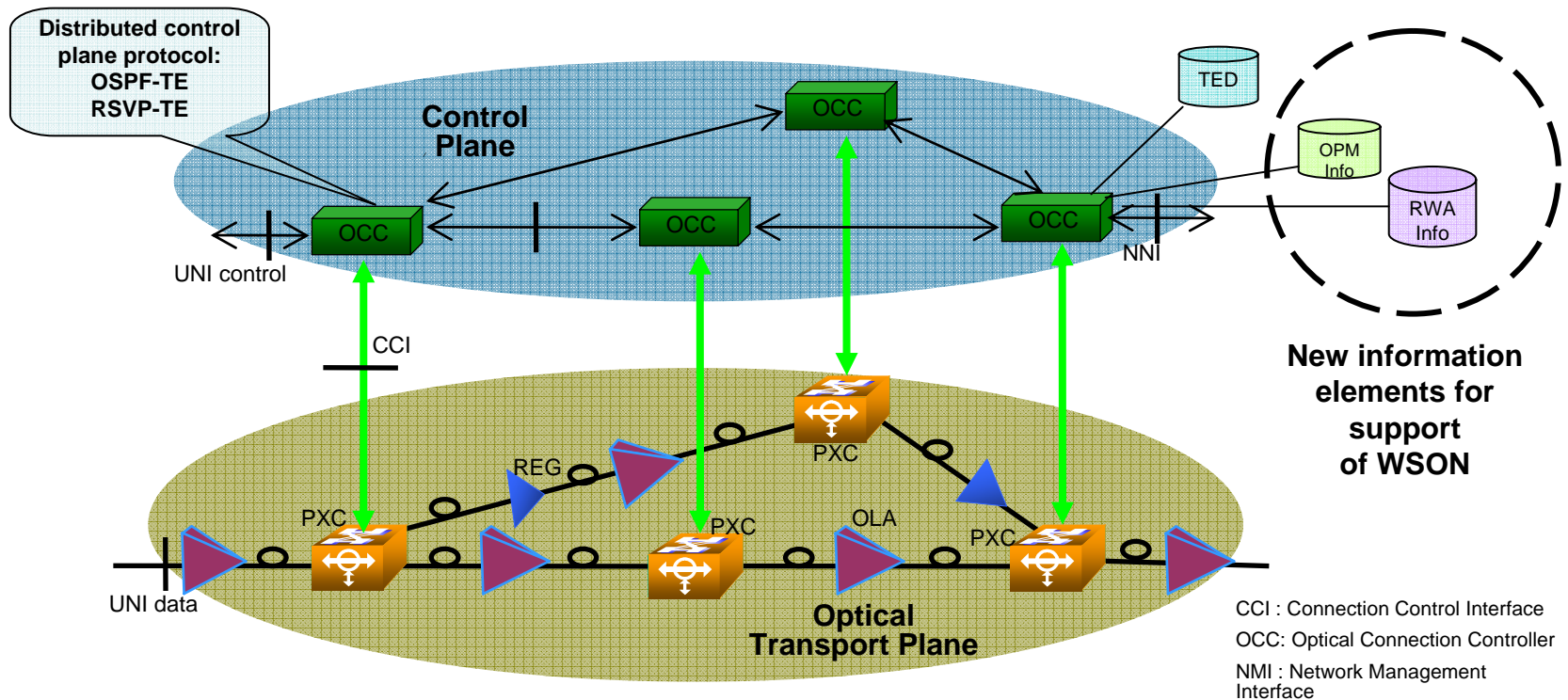

Distributed Control Plane:

- Based on TED (Traffic Engineering Database) via OSPF-TE
- Every node has the same view of the network based on TED
- Suitable for a simple/sequential Path Computation (via CSPF algorithm) and Path Provisioning (via RSVP-TE Signaling)

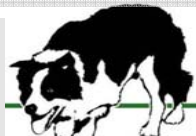

Combined GMPLS/PCE based Control Plane Architecture

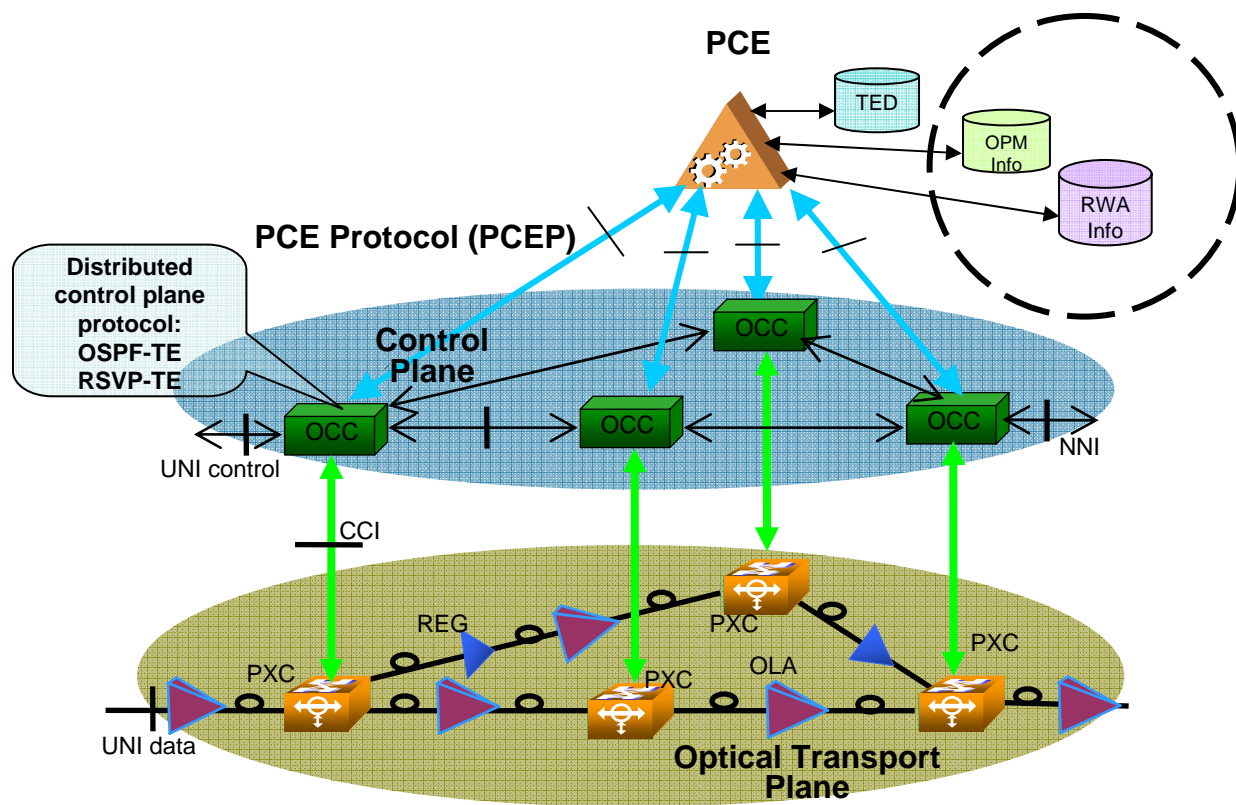

CCI : Connection Control Interface
 OCC: Optical Connection Controller
 NMI : Network Management Interface

- PCE complements GMPLS-based distributed control plane protocols.
- PCE is specialized for advanced constraints-based routing that include:
 - RWA Computation
 - ICBR Computation
- PCE is also specialized for global concurrent path computations
- PCE helps decrease information flooding that would be needed in IGP extensions to support RWA, ICBR, etc.
- PCE supports for recovery of wavelength switched optical networks

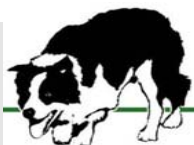

Global Concurrent Optimization (GCO)

- draft-pce-global-concurrent-optimization (work in progress)
- Global Concurrent Optimization (GCO) is a concurrent path computation application where a set of TE paths are computed concurrently in order to efficiently utilize network resources. A GCO path computation is able to *simultaneously* consider the *entire* topology of the network and the *complete* set of existing LSPs, and their respective constraints, and look to optimize or re-optimize the entire network to satisfy *all constraints* for all LSPs.
- The benefits of GCO are realized when multiple LSP requests come from different head-end nodes, which cannot be readily realized with a distributed sequential computation.

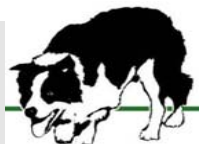

A sequential approach to path computation

Simple example – services requested from different nodes

1. Request a service  between **node-5** and **node-6** with bandwidth of 3Mbps and minimal cost
2. Then request a second service between **node-1** and **node-3** with bandwidth of 3Mbps and minimal cost

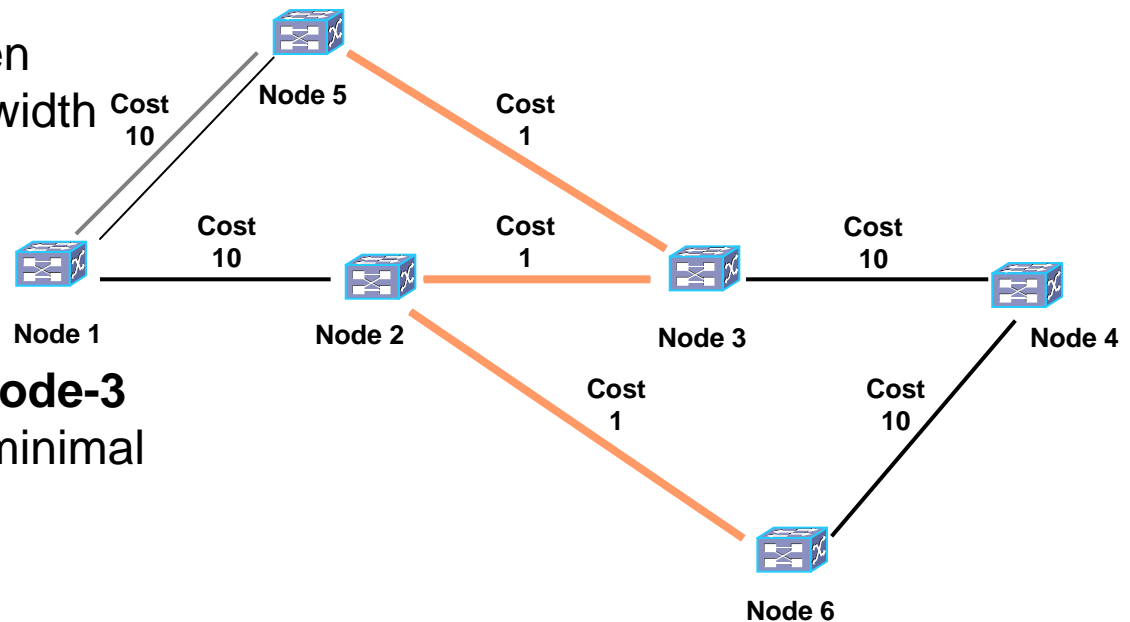

Service 1 – 3Mbps 

Service 2 – 3Mbps 



A concurrent approach to path computation

Simple example – services requested from different nodes

A concurrent operation would satisfy all service constraints

Service 1 – 3Mbps  

Service 2 – 3Mbps  

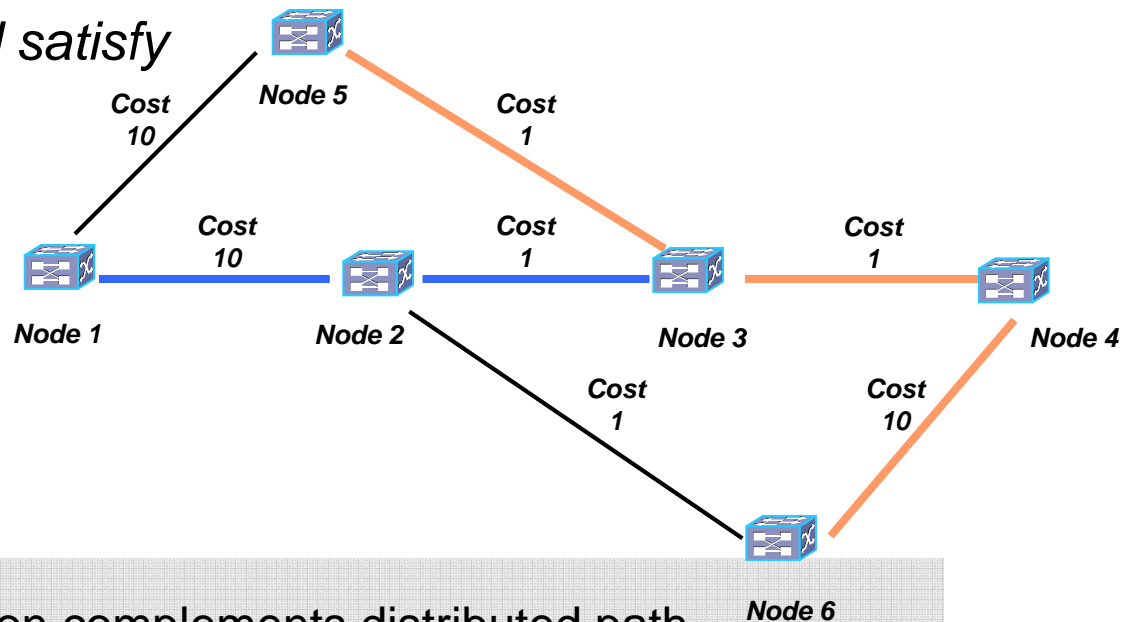

PCE-based path computation complements distributed path computation method based on OSPF-TE and CSPF by providing concurrent optimization capability

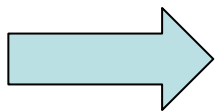

Concurrent PCE can be applied to WSON RWA Path Computation



Multi-Domain Path Computation

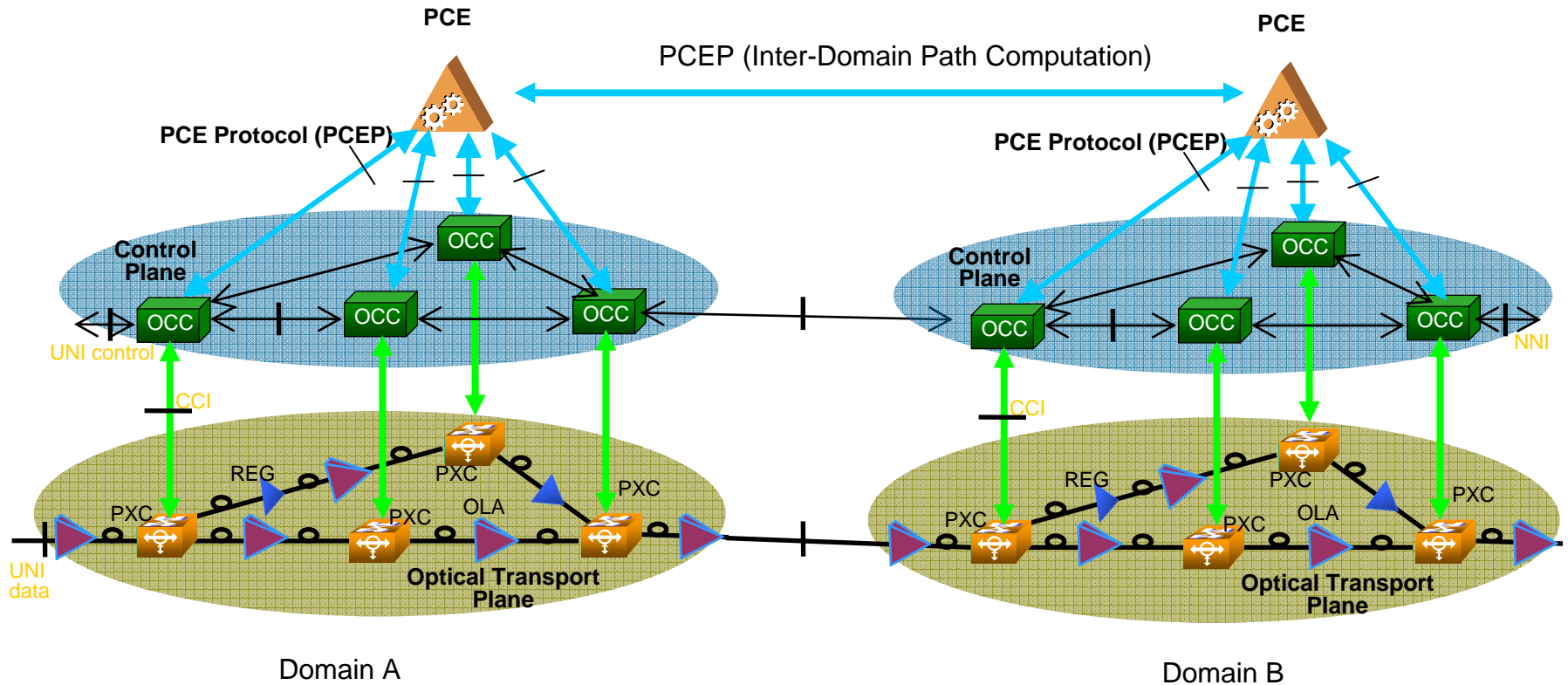

- PCE facilitates multi-domain path computation **without having to exchange domain specific information across domains.**
- PCEs in multi-domain maintain their client-server relationship for setting up an end-to-end path computation.

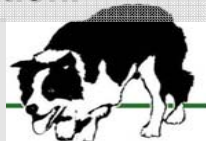

Per-Domain Path Computation

- Computational responsibility rests with domain entry point
- Path is computed across domain (or to destination)
- Works for contiguous, hierarchical, or stitched LSPs
- Which domain exit to choose for connectivity?
 - Follow IP routing? First approximation in IP/MPLS networks
 - Sequence of domains may be “known”
- Which domain exit to choose for optimality?

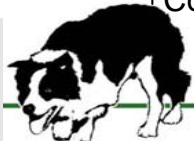
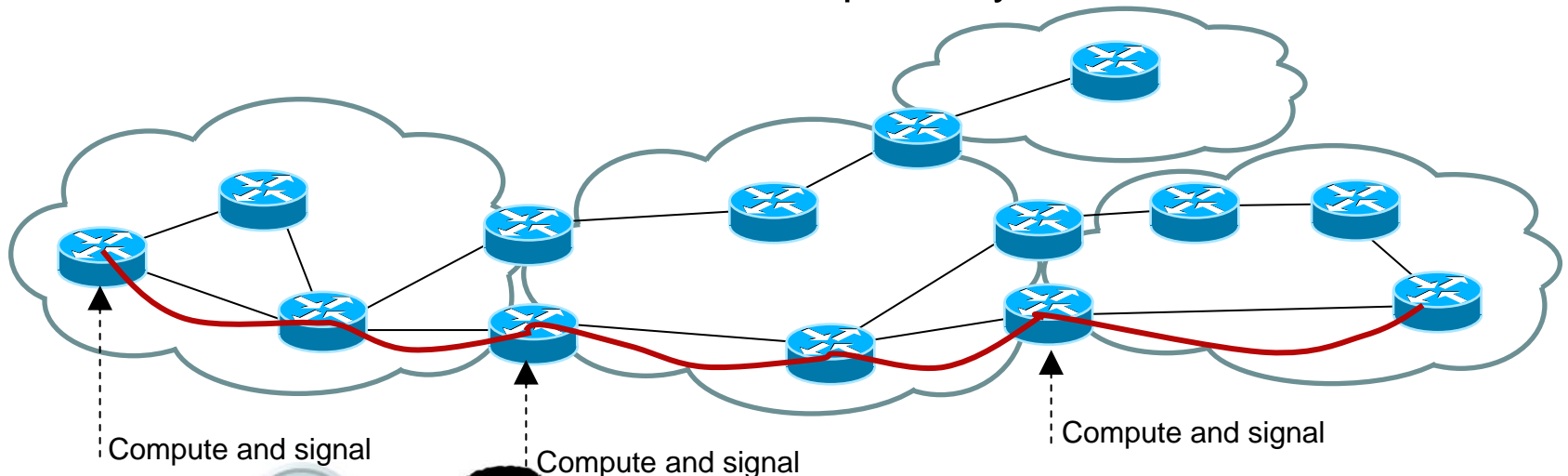

Backward Recursive Path Computation

- PCE cooperation
 - Can achieve optimality without full visibility
 - “Crankback at computation time”
- Backward Recursive Path Computation is one mechanism
 - Assumes each PCE can compute any path across a domain
 - Assumes each PCE knows a PCE for the neighbouring domains
 - Assumes destination domain is known
- Start at the destination domain
 - Compute optimal path from each domain entry point
 - Pass the set of paths to the neighbouring PCEs
- At each PCE in turn
 - Compute the optimal paths from each entry point to each exit point
 - Build a tree of potential paths rooted at the destination
 - Prune out branches where there is no/inadequate reachability
- If the sequence of domains is “known” the procedure is neater



BRPC Example

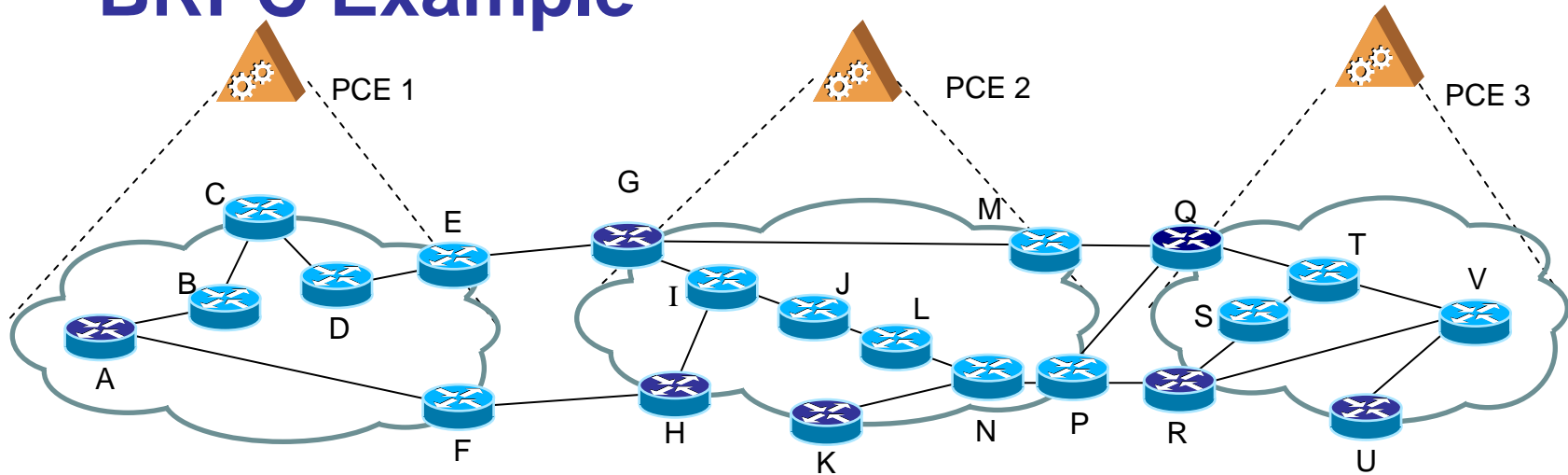

- PCE 3 considers:
 - QTV cost 2; QTSRV cost 4
 - RSTV cost 3; RV cost 1
 - UV cost 1
- PCE 3 supplies PCE 2 with the tree
- PCE 2 considers
 - GMQ..V cost 4; GIJLNPR..V cost 7; GIJLN PQ..V cost 8
 - HIJLNPR..V cost 7; HIGMQ..V cost 6; HIJLN PQ..V cost 8
 - KNPR..V cost 4; KNPQ..V cost 5; KNLJIGMQ..V cost 9
- PCE 2 supplies PCE 1 with the tree
- PCE 1 considers
 - ABCDEG..V cost 9
 - AFH..V cost 8
- PCE 1 selects AFHIGMQTV cost 8

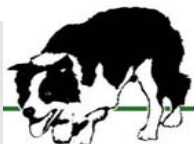
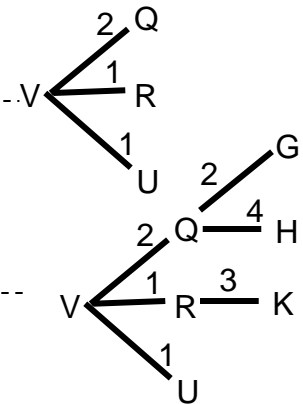

Multi-Layer Path Computation

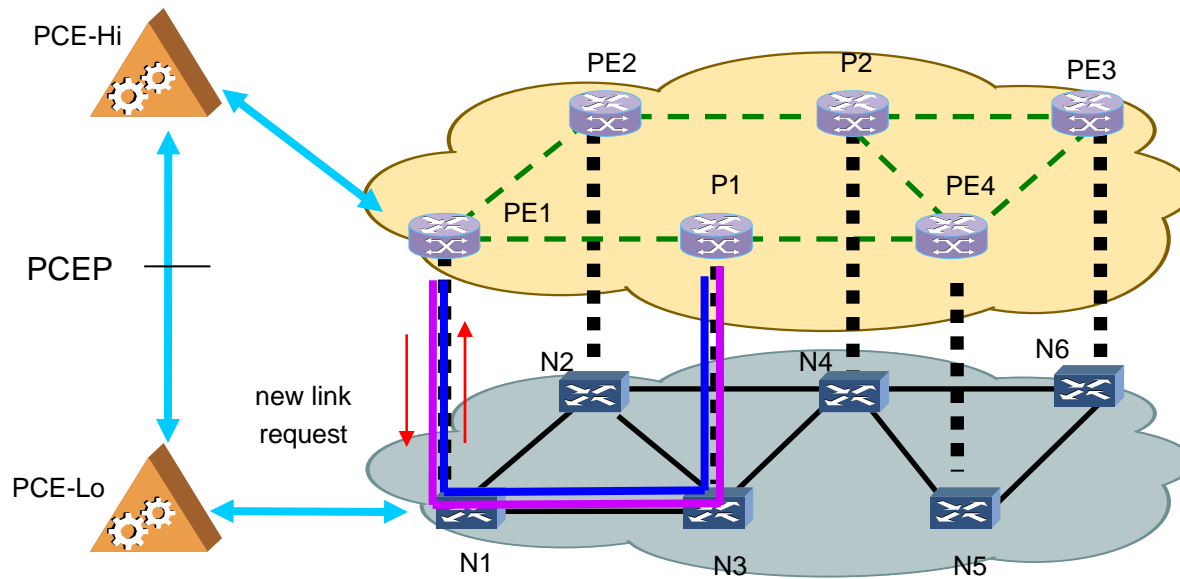

- PCE would also help multi-layer path computation such as optical bypass computation and cross-layer optimization and restoration



Standardisation Status and References

- G.8080/Y.1304: Architecture for the Automatic Switched Optical Networks (ASON)
- G.7713: Distributed Call and Connection Management (DCM)
- G.7715: Architecture and Requirements for Routing in the Automatically Switched Optical Networks
- G.7715.2: Applicability of PCE in an ASON environment
- RFC 4216: MPLS Inter-Autonomous System (AS) Traffic Engineering (TE) Requirements
- RFC 4105: Requirements for Inter-Area MPLS Traffic Engineering
- RFC 4726: A Framework for Inter-Domain Multiprotocol Label Switching Traffic Engineering
- RFC 4655: A Path Computation Element (PCE)-Based Architecture
- RFC 4206: Label Switched Paths (LSP) Hierarchy with Generalized Multi-Protocol Label Switching (GMPLS) Traffic Engineering (TE)
- RFC5150: LSP Stitching with Generalized MPLS TE
- RFC5152: : A Per-domain path computation method for establishing Inter-domain Traffic Engineering (TE) Label Switched Paths (LSPs)
- draft-ietf-pce-brpc: A Backward Recursive PCE-based Computation (BRPC) procedure to compute shortest inter-domain Traffic Engineering Label Switched Paths (work in progress)



Summary

- By combining the ITU-T's ASON architecture model with the IETF's PCE concepts, high-function and flexible solutions can be achieved that addresses the challenges of path computation in a multi-domain optical networks.
- Experimental results show that the application of PCEs to compute end-to-end paths in multi-domain optical networks is a viable solution.

